

## Changeover Support

MOVIDRIVE<sup>®</sup> A  
MOVIDRIVE<sup>®</sup> compact  
to MOVIDRIVE<sup>®</sup> 60/61 B  
Sizes 0-6

November 2003



Authors:

Helmut Keller

Gerald Schneeloch

GE-ATS

GE-ATS

This document has been prepared on the basis of the current status of knowledge. Consequently, subsequent discoveries may lead to different statements. As a result, the possibility of misinterpretations or mistakes in the technical data cannot be ruled out.

## Preface

This document is intended to support sales activities by dealing with current and general questions relating to technology and the project planning of products.

Please do not hesitate to contact the authors if you have any questions or suggestions.

Authors: Helmut Keller                    07251 / 75 - 1115  
             Gerald Schneeloch            07251 / 75 – 1185

## Contents

<b>1</b>	<b>Comparison of Technical Data</b>	<b>4</b>
<b>2</b>	<b>Mounting Position and Connection</b>	<b>6</b>
2.1	MOVIDRIVE® B BG0	6
2.2	MOVIDRIVE® B ab BG1	8
<b>3</b>	<b>Units and Options</b>	<b>11</b>
3.1	MOVIDRIVE® MDx60A	11
3.2	Connection of MOVIDRIVE® MDx60A	12
3.3	MOVIDRIVE® compact	13
3.4	MCF/MCV/MCS standard connection	14
3.5	MCH standard connection	15
3.6	Fieldbus interfaces	16
3.7	I/O expansion	16
3.8	Angular synchronous operation and absolute encoder input SSI	16
<b>4</b>	<b>Movitools, Parameters and IPOS</b>	<b>17</b>
4.1	Baud rate setting	17
4.2	New parameters	17
4.3	Modified parameters	18
4.4	Deleted parameters:	18
4.5	Modified layout	18
4.6	IPOS	19
4.7	Application modules	19
4.8	Communication via SBus	19
<b>5</b>	<b>Accessories</b>	<b>20</b>
5.1	Plain text keypad	20
5.2	EMC / filters / chokes	20
5.3	Braking resistor	20
5.4	Serial interface	20
5.5	Line regeneration and DC link connection	20
<b>6</b>	<b>Summary</b>	<b>21</b>

## 1 Comparison of Technical Data

The technical data of MOVIDRIVE® A (MD\_60A), MOVIDRIVE® COMPACT (MC\_4\_A) and of MOVIDRIVE® B (MDX6\_B) hardly differ. Line cross sections and fusing therefore remain the same. Differences only occur when MOVIDRIVE® B size 0 units are used that can be used more optimally due to their graduated power range between 0.5 and 1.5 kW.

	MDX6_B	MC_4_A – MD_60A
<b>Interference immunity</b>	meets EN 61800-3	
<b>Interference emission with EMC-compliant installation</b>	According to class B limit to EN 55011 and EN 55014; complies with EN 61800-3 To class A limit for sizes 0, 1 and 2 on line side. EN 55011 and EN 55014 without additional measures	
<b>Ambient temperature <math>J_U</math></b>	0°C...+50°C at $I_D = 100\% I_N$ and $f_{PWM} = 4 \text{ kHz}$ 0°C...+40°C at $I_D = 125\% I_N$ and $f_{PWM} = 4 \text{ kHz}$ 0°C...+40°C at $I_D = 100\% I_N$ and $f_{PWM} = 8 \text{ kHz}$	
<b>Derating ambient temperature Climate class</b>	PN reduction: 3.0% $I_N$ per K to max. 60°C EN 60721-3-3, class 3K3	
<b>Storage temperature 1)</b>	-25 °C – +70 °C (EN 60721-3-3, class 3K3) DBG keypad: -20°C – +60 °C	
<b>Cooling type (DIN 51751)</b>	Forced cooling	
<b>Enclosure sizes 0 to 3 EN 60529 sizes 4 to 6 (NEMA1)</b>	IP20 IP00 (power connections); IP10 with Plexiglas cover mounted (supplied as standard)	
<b>Operating mode</b>	DB (EN 60149-1-1 and 1-3)	
<b>Installation altitude</b>	h ≤ 1000 m (3300 ft) IN reduction: 1 % per 100 m (330 ft) from 1000 m (3300 ft) to max. 2000 m (6600 ft)	

	MDX6_B 0005- 5A3-4-0	MDX6_B 0008- 5A3-4-0	MDX6_B 0011- 5A3-4-0	MDX6_B 0014- 5A3-4-0	MDX61B 0015-5A3- 4-0	MC_4_A / MD_60A 0015-5A3-4-0
<b>Size</b>	0S		0M		1	1
<b>INPUT</b>						
<b>Supply voltage <math>V_{mains}</math></b>	3 x 380 V <sub>AC</sub> -10% ... 3 x 500 V <sub>AC</sub> +10%					
<b>Mains frequency <math>f_{mains}</math></b>	50 Hz ... 60 Hz $\pm$ 5%					
<b>Rated system current <math>I_{mains}</math> 100%</b>	1.8 A <sub>AC</sub>	2.2 A <sub>AC</sub>	2.8 A <sub>AC</sub>	3.6 A <sub>AC</sub>	3.6 A <sub>AC</sub>	3.6 A <sub>AC</sub>
<b>(for <math>V_{mains} = 3 \times 400 \text{ V}_{AC}</math>) 125%</b>	2.3 A <sub>AC</sub>	2.7 A <sub>AC</sub>	3.5 A <sub>AC</sub>	4.5 A <sub>AC</sub>	4.5 A <sub>AC</sub>	4.5 A <sub>AC</sub>
<b>OUTPUT</b>						
<b>Rated output power <math>2 P_r</math> (bei <math>U_{Netz} = 3 \times 380 \dots 500 \text{ V}_{AC}</math>)</b>	1.4 kVA	1.6 kVA	2.1 kVA	2.8 kVA	2.8 kVA	2.8 kVA
<b>Rated output current <math>I_N</math> (for <math>V_{mains} = 3 \cdot 400 \text{ V}_{AC}</math>)</b>	2.0 A <sub>AC</sub>	2.4 A <sub>AC</sub>	3.1 A <sub>AC</sub>	4.0 A <sub>AC</sub>	4.0 A <sub>AC</sub>	4.0 A <sub>AC</sub>
<b>Current limitation <math>I_{max}</math></b>	200% $I_N$			150% $I_N$		
<b>Internal current limitation</b>	motorisch und generatorisch, Dauer abhängig von der Auslastung					
	$I_{max} = 0 \dots 200\%$			$I_{max} = 0 \dots 150\%$		
	can be set in menu (P303 / P313)					
<b>Minimum permitted brake resistance value (4Q operation) <math>R_{Bwmin}</math></b>	68 $\Omega$					
<b>Output voltage <math>V_o</math></b>	max. $V_{mains}$					
<b>PWM frequency <math>f_{PWM}</math></b>	Adjustable: 4/8/16 kHz (P860 / P861)					
<b>Speed range /</b>	-6000 ... 0 ... +6000 min <sup>-1</sup>					-5000 ... 0 ... +5000 min <sup>-1</sup>
<b>Resolution <math>n_A / .n_A</math></b>	0.2 min <sup>-1</sup> over the entire range					
<b>GENERAL</b>						
<b>Power loss at <math>P_L P_{Lmax}</math></b>	42 W	48 W	58 W	74 W	85 W	85 W
<b>Cooling air consumption</b>	3 m <sup>3</sup> /h (1.8 ft <sup>3</sup> /min)		9 m <sup>3</sup> /h (5.4 ft <sup>3</sup> /min)		40 m <sup>3</sup> /h (24 ft <sup>3</sup> /min)	40 m <sup>3</sup> /h (24 ft <sup>3</sup> /min)
<b>Constant load Recommended motor power <math>P_{Mot}</math></b>	0.55 kW (0.75 HP)	0.75 kW (1.0 HP)	1.1 kW (1.5 HP)	1.5 kW (2.0 HP)	1.5 kW (2.0 HP)	1.5 kW (2.0 HP)
<b>Variable torque load or constant load without overload Recommended motor power <math>P_{Mot}</math></b>	0.75 kW (1.0 HP)	1.1 kW (1.5 HP)	1.5 kW (2.0 HP)	2.2 kW (3.0 HP)	2.2 kW (3.0 HP)	2.2 kW (3.0 HP)
<b>Continuous output current = 125% <math>I_N I_D</math> (for <math>V_{mains} = 3 \times 400 \text{ V}_{AC}</math> and <math>f_{PWM} = 4 \text{ kHz}</math>)</b>	2.5 A <sub>AC</sub>	3.0 A <sub>AC</sub>	3.8 A <sub>AC</sub>	5.0 A <sub>AC</sub>	5.0 A <sub>AC</sub>	5.0 A <sub>AC</sub>
<b>CFC operating mode Continuous output current = 100% <math>I_N I_D</math></b>	2.0 A <sub>AC</sub>	2.4 A <sub>AC</sub>	3.1 A <sub>AC</sub>	4.0 A <sub>AC</sub>	4.0 A <sub>AC</sub>	4.0 A <sub>AC</sub>

1 The system and output currents must be reduced by 20 % from the nominal values for  $V_{mains} = 3 \times 500 \text{ V}_{AC}$ .

2 The performance data apply to  $f_{PWM} = 4 \text{ kHz}$  (factory setting in VFC operating modes).

Sizes 1 to 6 have the same technical data. This table therefore does not include a comparison with these sizes. With the B unit, the speed range is  $-6000 \dots 0 \dots 6000 \text{ min}^{-1}$  for all sizes. The current limitation with the B unit is 150 %  $I_N$  starting from size 1, and 200 %  $I_N$  for size 0.

For sizes 1 to 6, the same cable lengths apply as for the A unit.  
The following values apply to size 0:

VFC	Shielded	Unshielded
4kHz	100m	200m
8kHz	70m	140m
12kHz	50m	100m
16kHz	40m	80m

## 2 Mounting Position and Connection

### 2.1 MOVIDRIVE<sup>®</sup> B size 0

MOVIDRIVE<sup>®</sup> B size 0 differs from MOVIDRIVE<sup>®</sup> A and MOVIDRIVE<sup>®</sup> compact size 1 in depth, height and width. The slim design of the B unit and the possibility to mount the units using a positive connection result in considerable space-saving installation. With respect to the depth, however, the unit requires additional space of about 100 mm compared to MC\_4\_A units. Compared to MD\_60A units, the installation depth is reduced by 13 mm.

The holes for the retaining screws are only 280 mm apart from each other on the MDX6\_B unit. This means that new holes for retaining screws must be provided.

Power and motor connection only differ in so far as 4-pin connectors must be used for the B unit (PE in addition).

The terminals for DC link voltage and braking resistor are identical.

MDX60B

BG0

BG0S

BG0M

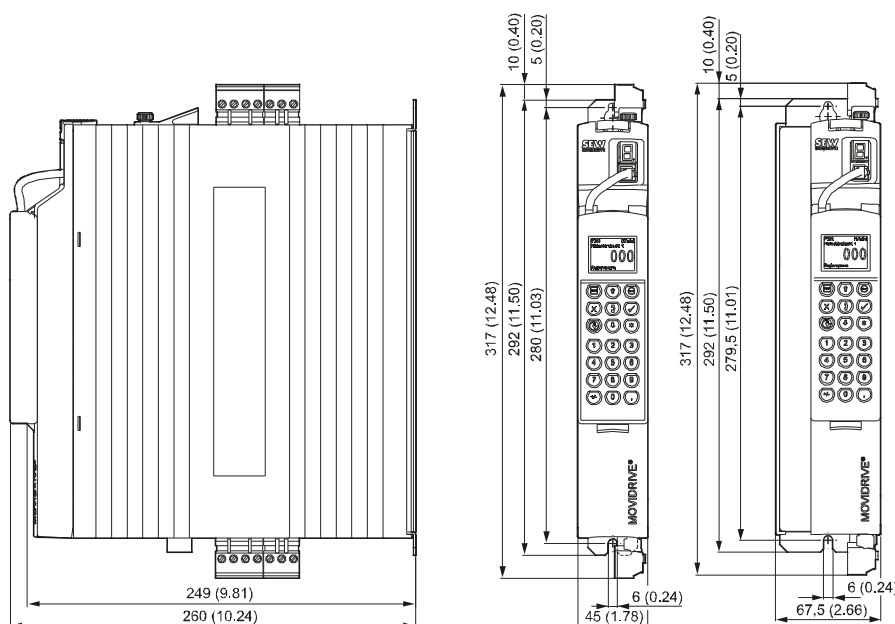

MDX61B

BG0

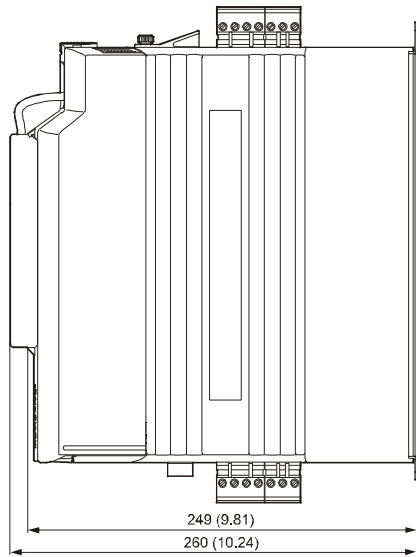

BG0S

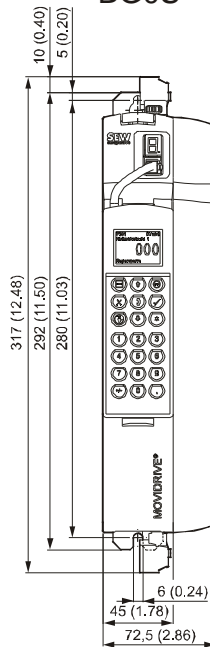

BG0M

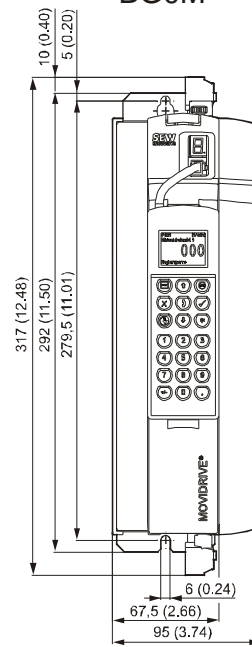

## MOVIDRIVE® compact size 1

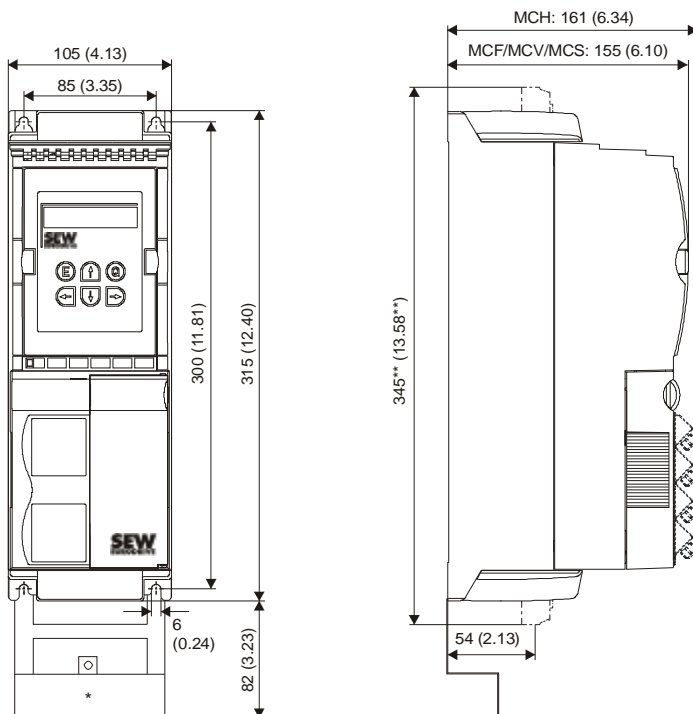

## MOVIDRIVE® A size 1

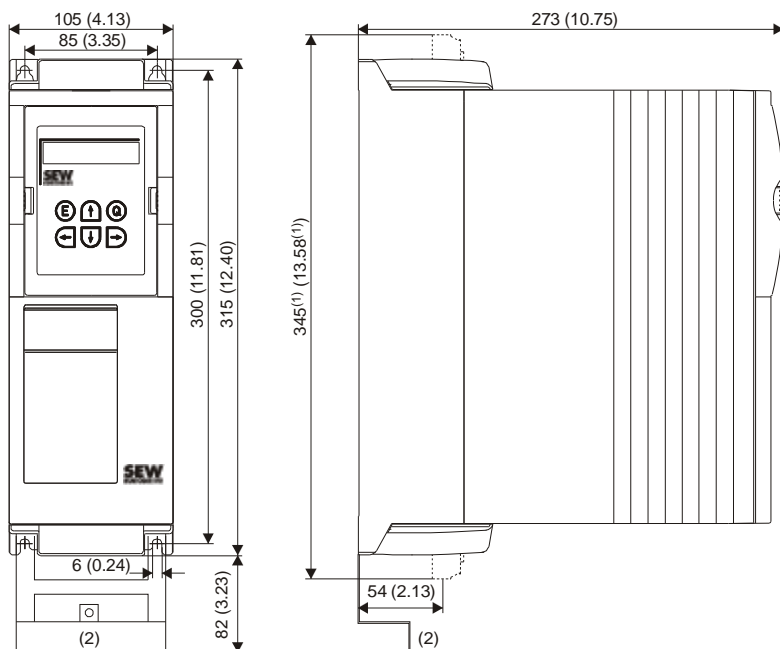

## 2.2 MOVIDRIVE<sup>â</sup> B starting from size 1

Starting from size 1, the B unit mainly differs in the depth. This means it requires 81 mm more than the MC\_4\_A unit. Compared to the MD\_60A unit, the installation depth is reduced by 40 mm. Height, width and bores remain the same because the same power section is used. A deviation only occurs in the power ranges 5.5 – 11kW where a size 2S (5.5kW and 7.5kW/5,5 – 11kW) was included. In this case, the holes for the retaining screws differ due to the slim design.

## MOVIDRIVE® compact size 2

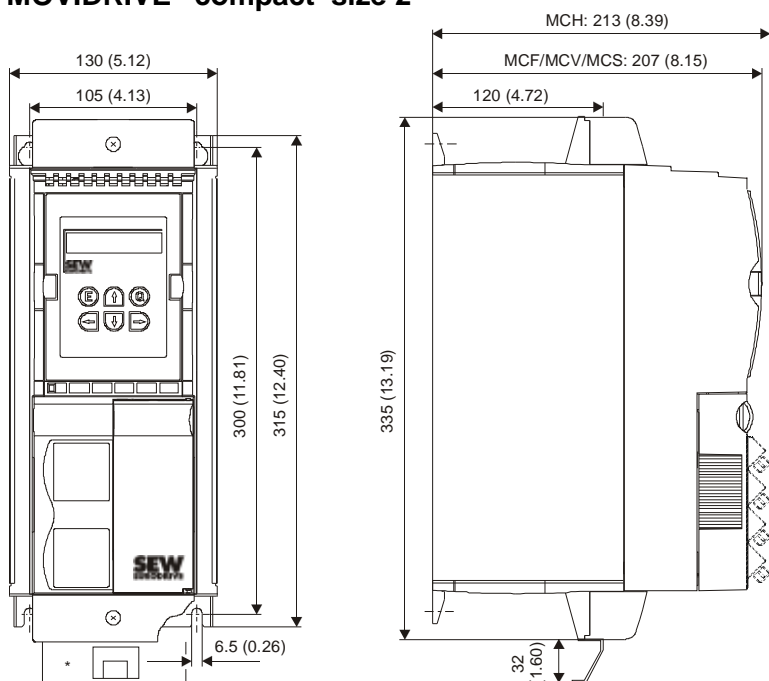



**MOVIDRIVE® compact size 2**

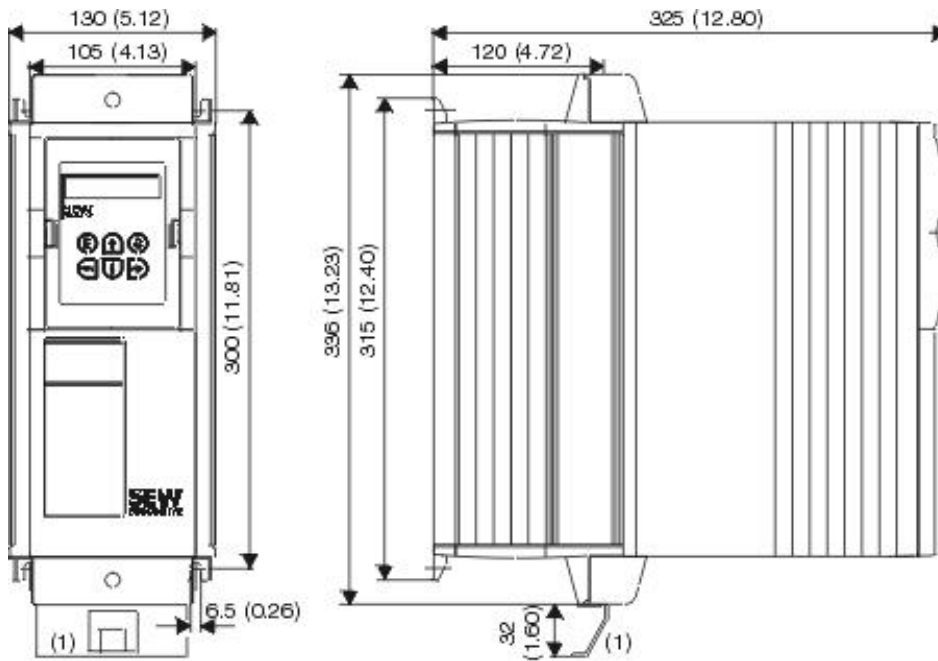

**MOVIDRIVE® B size 2S**

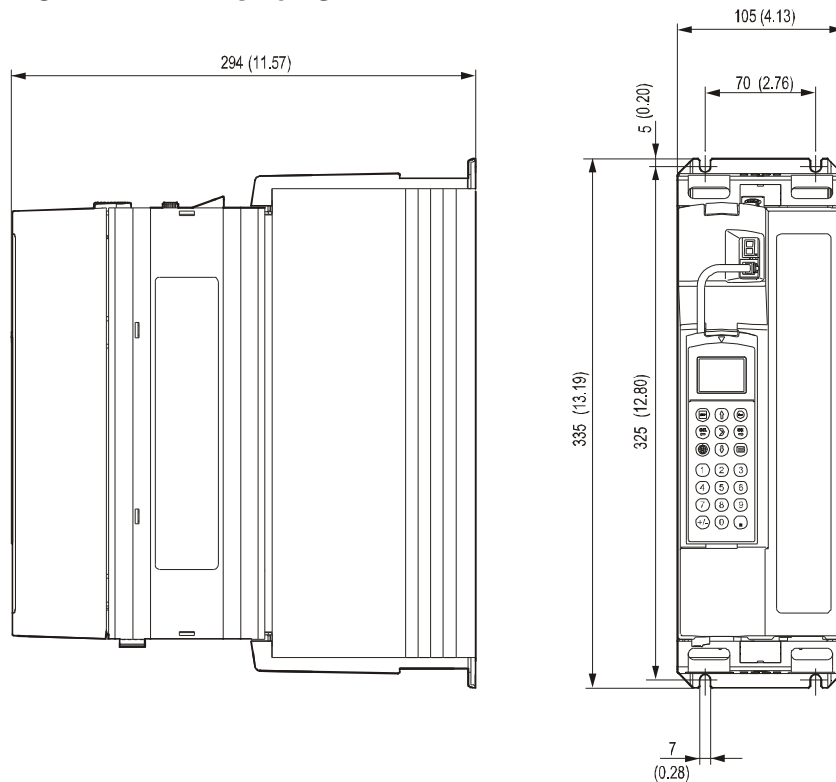

**MOVIDRIVE® B size 2**  
285 (11.22)

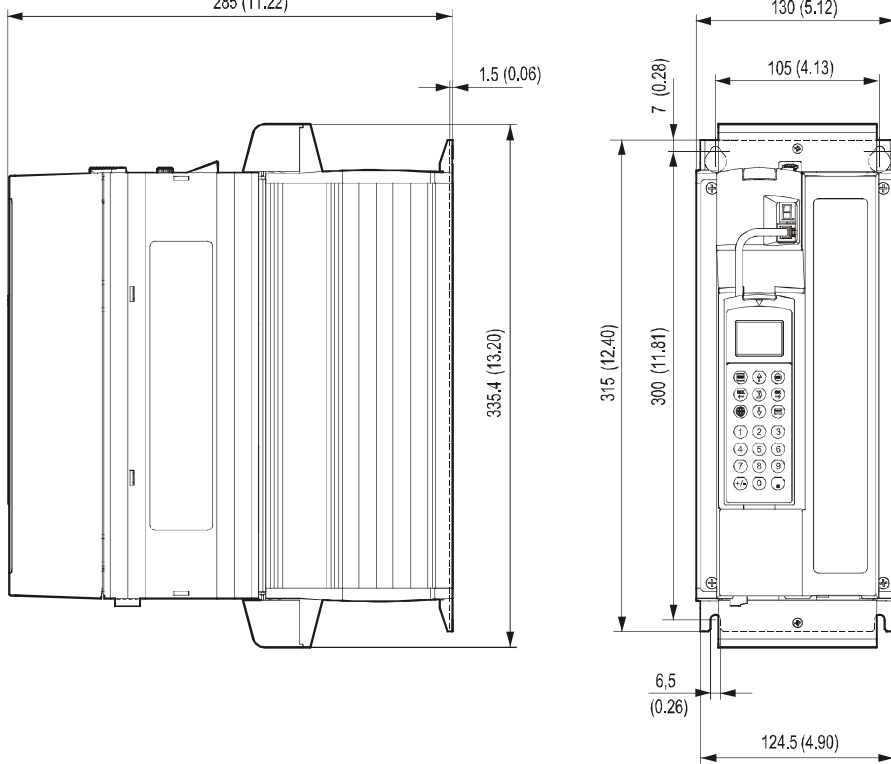





### 3 Units and Options

Now there is only one basic unit for the B unit. The basic unit is equipped with the corresponding options. This results in different designs for some connectors.

#### 3.1 MOVIDRIVE<sup>â</sup> MDx60A

With power ratings smaller or equal 1.5 kW, an MDF60A unit without option cards can be replaced by the MDX60B (size 0). An MDX61B must be used for MDV60A, MDS60A and with larger power as well as when options cards are used, As the number of pins and the pin assignment of connectors X14 and X15 are different when using an encoder card (exception X15 MDS), adapters are offered for fast and fault-free exchange.

						Adapter		Adapter DAT11B
						DAE__		
						14B for X14	15B for X15	
MDF60A		<=1.5kW without options	>=1.5kW					
MDV60A								
MDS60A								

## 3.2 Connection of MOVIDRIVE<sup>â</sup> MDx60A

The terminal connections of MDx60A and MDX\_B are identical. The only difference is the orientation of the connectors. With the A unit, the curvature of the connectors is on the right side, with the B unit it is on the left side. When replugging the connectors, pin 1 of terminal X11, for example, would then be pin 5. As there is no other solution available from the connector manufacturers, the terminal adapter DAT11B was designed for fast and fault-free replacement. Terminal X10 can be replugged directly.

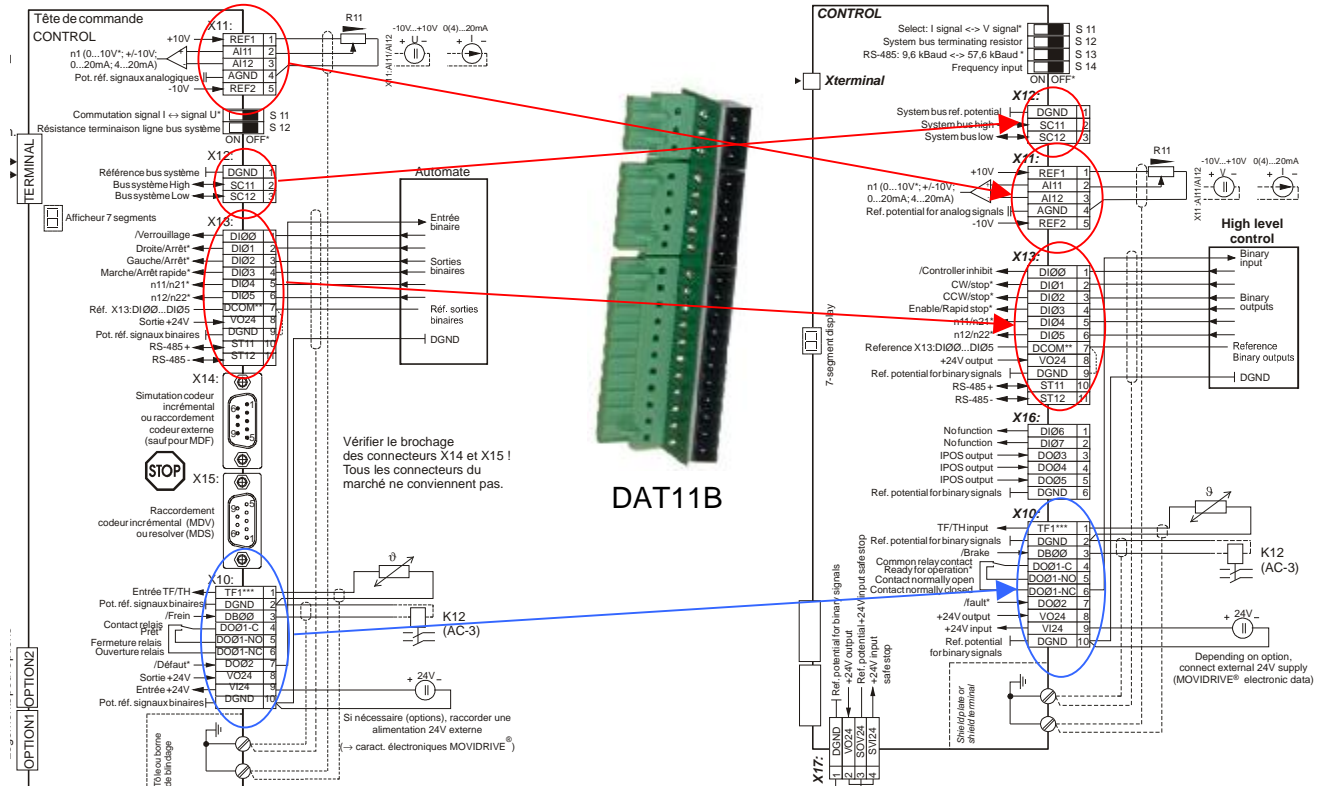







### 3.3 MOVIDRIVE<sup>â</sup> compact

With power ratings smaller or equal 1.5 kW, an MCF40A unit can be replaced by the MDX60B without additional cards (size 0). With MCV4xA, MCS4xA, MCH4xA and in the case of larger power ratings, An MDX61B must be used. An MCx41A or MCx42A unit can be replaced by an MDX61B with corresponding fieldbus card.

Usually, adapters are required for the encoder plugs because of the different number of pins. An exception is the X15 of the MCS unit and the encoder plug of MCH4xA.

If an MCH is replaced in conjunction with the SBus, please observe the notes in section "Communication via SBus."

	MDX60B	MDX61B	DER11B	DEH11B	Adapter		DFP21B	DFI21B
					DAE__			
					14B for X14	15B for X15		
MCF40A	<=1.5kW	>=1.5kW						
MCF41A								
MCF42A								
MCV40A								
MCV41A								
MCV42A								
MCS40A								
MCS41A								
MCS42A								
MCH41A								
MCH42A								

## 3.4 MCF/MCV/MCS standard connection

The standard connections are nearly identical in terms of terminal functionality. However, as the terminals in this unit series are non-pluggable terminal screws, the connections have to be changed.

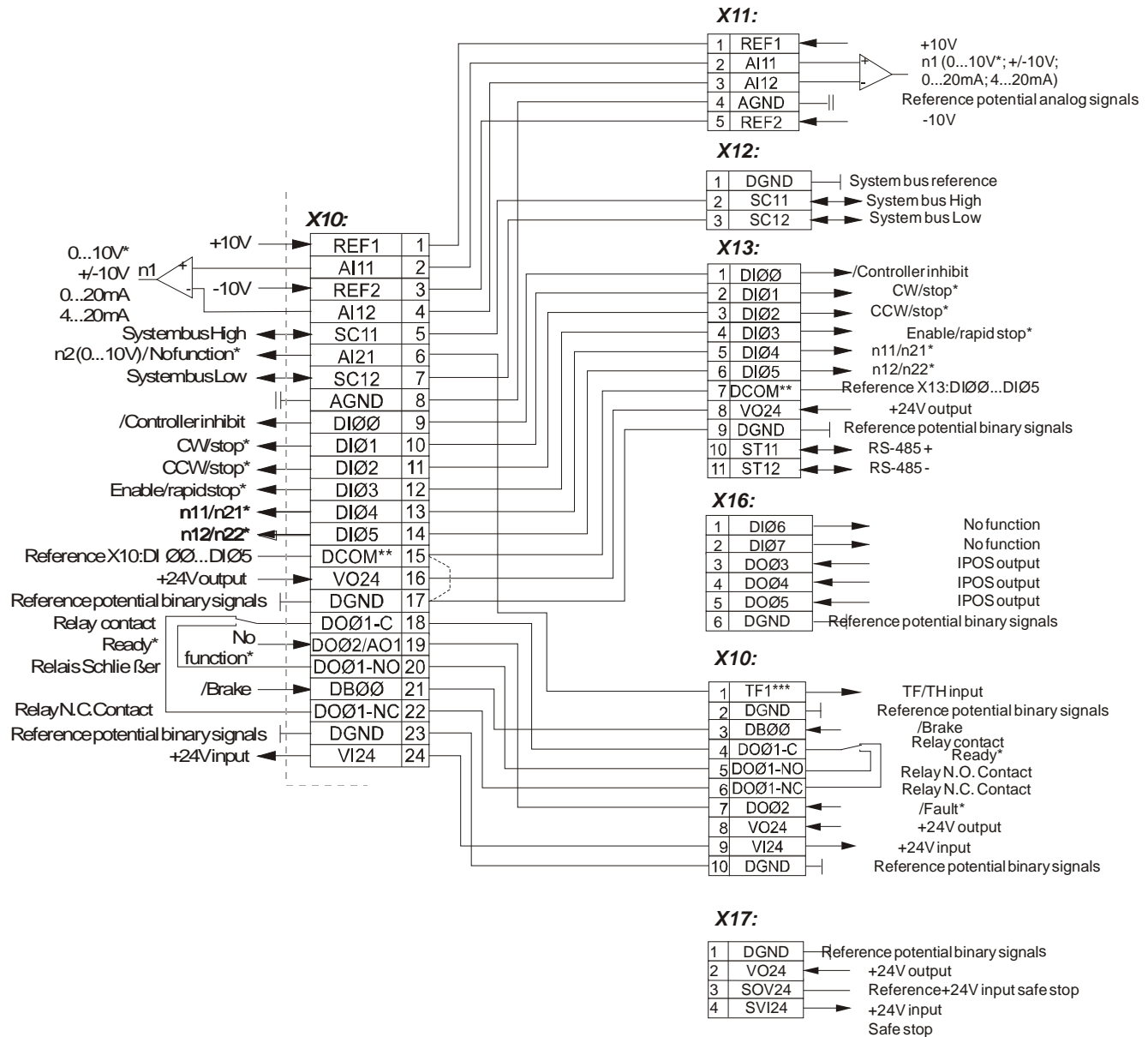

### 3.5 MCH standard connection

Here as well, the standard connections are nearly identical in terms of terminal functionality. The terminals of this unit series, however, are pluggable terminals. These pluggable terminals are not compatible with the B unit. The connections must therefore be changed.

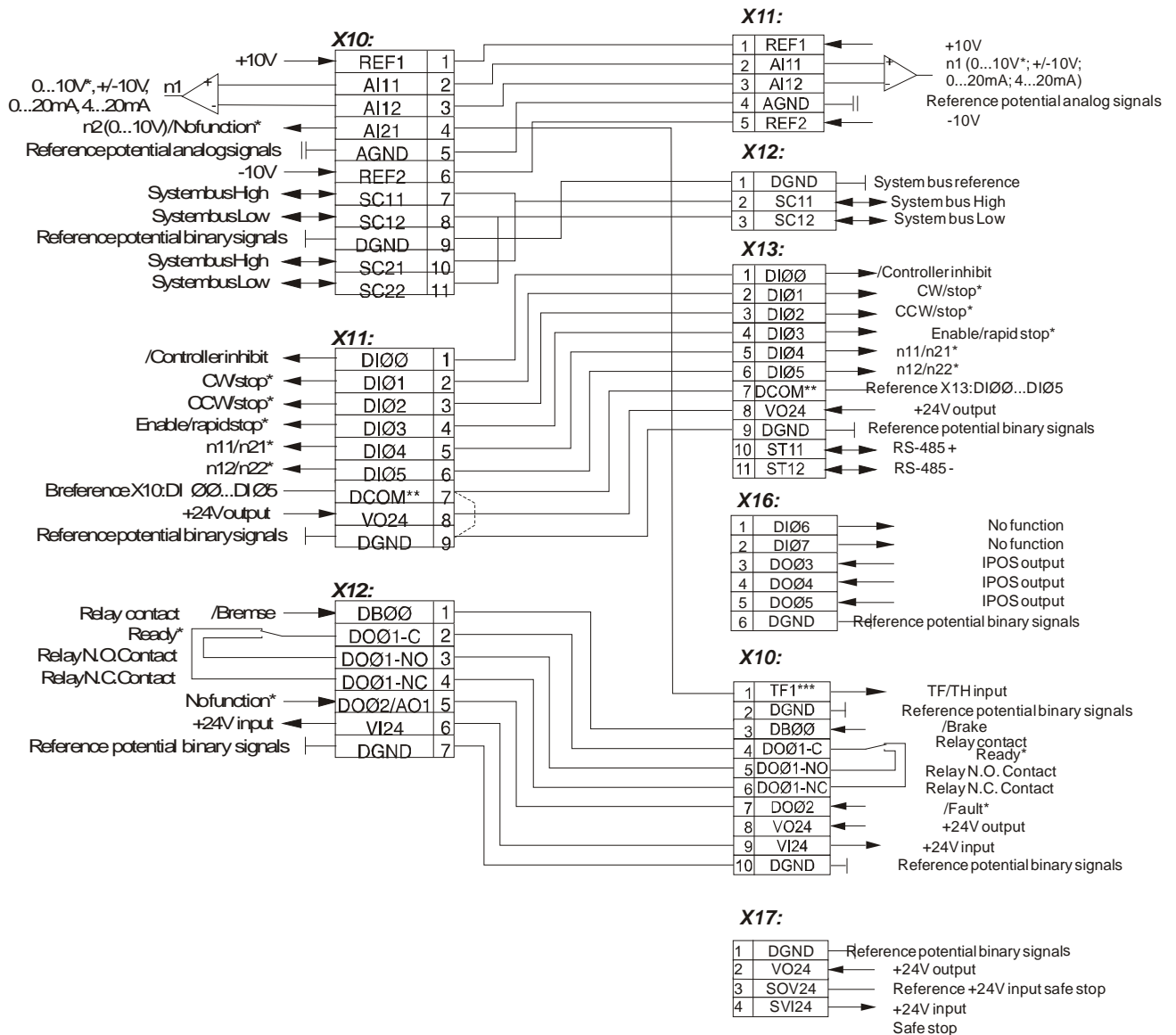

### 3.6 Fieldbus interfaces

**DFP21A:** The card is 100 % compatible with the former cards DFP11A, DFP21A and MOVIDRIVE® compact. The DPV1 protocol provides additional functions, which need not be used however. All other cards are also 100 % compatible.

Card for MOVIDRIVE <sup>â</sup> A	Bus	Card for MOVIDRIVE <sup>â</sup> B
DFP11A, DFP21A	Profibus	<b>DFP21A</b>
DFI11A	Interbus (copper)	<b>DFI11B</b>
DFI21A	Interbus (LWL),	<b>DFI21B</b>
DFD11A	DeviceNet	<b>DFD11B</b>
DFC11A, DFO11A	CAN / CANopen	<b>DFC11B</b>

### 3.7 I/O expansion

In terms of functionality, DIO11B is fully compatible with DIO11A. But there is a difference in the terminals. The terminals were reduced to 3.81 mm. This means the terminals must be rewired in case of replacement. Another important point is that the outputs require external voltage supply. A DIO11B and a fieldbus card cannot be plugged simultaneously in the BG0 unit. Starting from size 1, however, the DIO11B can be plugged both in the fieldbus and in the expansion slot.

### 3.8 Angular synchronous operation and absolute encoder input SSI

The angular synchronous card (DRS11B) and the absolute encoder input SSI (DIP11B) are 100 % compatible with the previous DRS11A and DIP11A. All encoders that were permitted in the DIP11A can be used in the DIP11B without restrictions. The cards can only be used starting from size 1 because of the required option slot.



## 4 Movitools, Parameters and IPOS

MOVITOOLS version 4 and higher is required for the B unit. When changing to another unit, the parameters can directly be adopted. It is possible to load MDX files of the A unit into the B unit, and to copy inverter data via the RS485 interface.

### 4.1 Baud rate setting

A novelty is that the baud rate can be set. As standard, the baud rate for the B unit is set to 57.6 kBaud. On the unit, the baud rate can be set via DIP switch on the front, in the software the baud rate can be selected in the Manager window. The baud rate set on the unit and in the software must be identical.

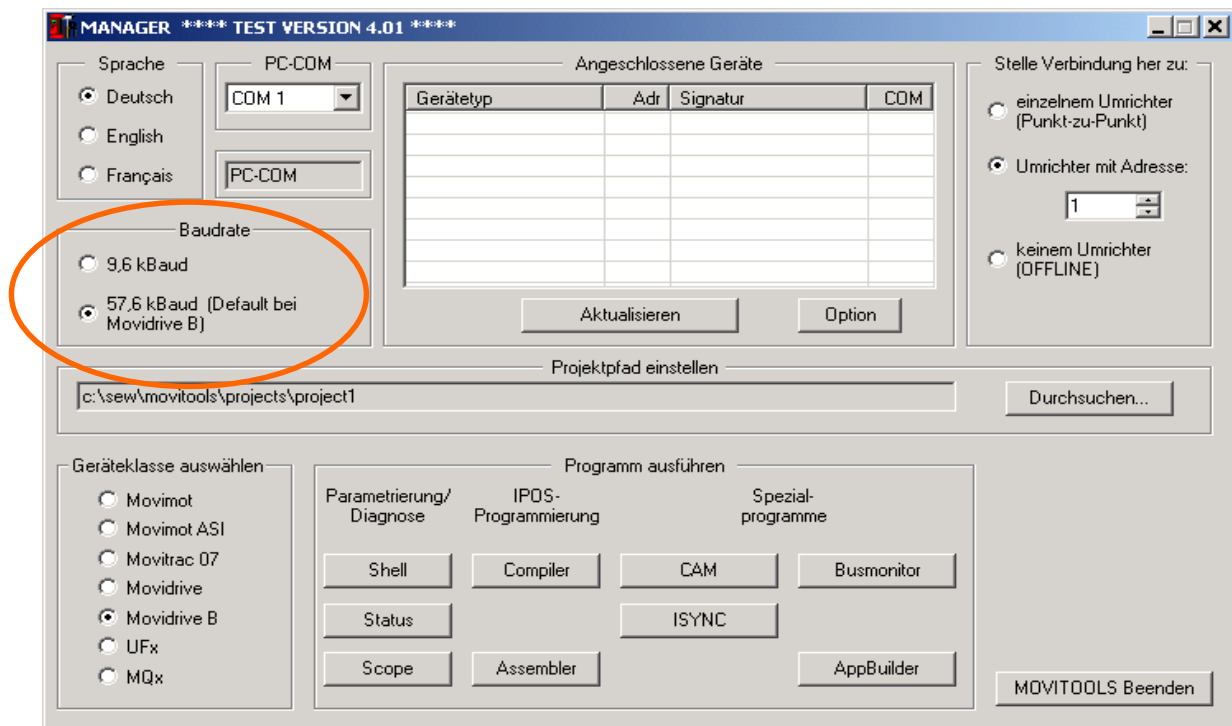

### 4.2 New parameters

The following parameters were added:

#	Parameter name	
P102	Frequency scaling [kHz]	Scaling of the frequency input
P605	Binary input DI06	New inputs/outputs
P606	Binary input DI07	
P622	Binary output DO03	
P623	Binary output DO04	
P624	Binary output DO05	
P760	Lockout run/stop keys	Manual mode is locked
P837	Response timeout SBus 2	Fault respons to timeout SBus 2
P838	Fault response SW limit switch	Fault response to software limit switch
P890-896	Protocol SBus 2	Settings for SBbus 2 (option card)
P917	Ramp mode	Type of ramps used (IPOS)
P938	IPOS speed task 1	Point scoring system according to which priorities are assigned to tasks 1 and 2.
P939	IPOS speed task 2	

## 4.3 Modified parameters

Some parameter blocks were modified or their position was altered to comply with the expanded functionality.

Old #	New #	Parameter name
	P160-P162 P170-P172	Changed layout, functionality remains the same.
P813	P881,P891	Address SBus 1,2
P814	P882,P892	Group address SBus 1,2
P815	P883,P893	Timeout time SBus 1,2
P816	P884,P894	Baud rate SBus 1,2
P817	P885,P895	Synchronization ID SBus 1,2
P818	P886,P896	CAN synchronization 1,2
P836	P836,P837	Response timeout SBus 1,2

## 4.4 Deleted parameters:

In Movitools version 3.0, it was possible to make a selection in these parameters. This selection did not have any effect, however. These parameters are not required anymore because /Controller inhibit or brake will be assigned to input DI00 and output DO00.

#	Parameter name	Parameter name
P608	Binary input DI00	Binary input DI00
P628	Binary output DO00	Binary output DO00

## 4.5 Modified layout

The input window for fixed setpoints was slightly modified to allow clearer assignment.

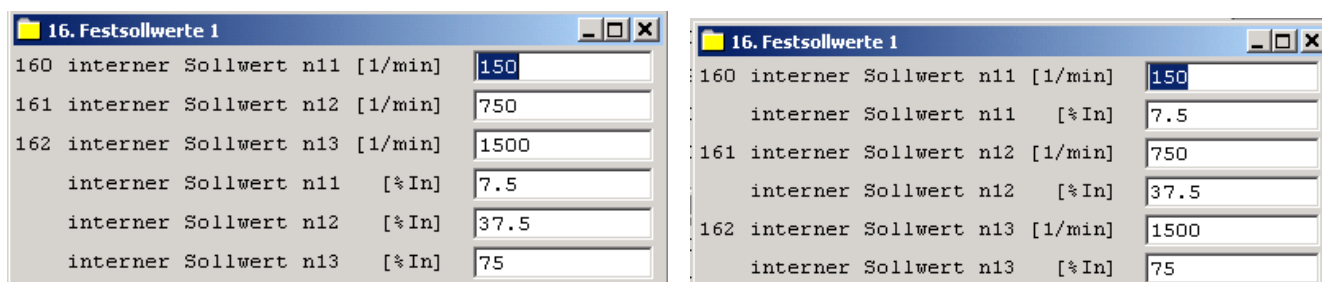

## 4.6 IPOS

Programs from the A unit can be directly adopted. But to achieve full compatibility, the speed of tasks 1 and 2 must not be increased.

The most important novelty in IPOS programming is the additional task 3, which offers new options for IPOS programming. It is important that task 3 does not have a fixed time sharing division but is dependent on the utilization of tasks 1 and 2. But at least one instruction/ms will be interpreted. With the B unit, the setpoint access takes only 1 ms (instead of 5 ms).

IPOS speed P938/P939:

The speeds of tasks 1 and 2 can be set using these parameters. Task 1 obtains at least one point, task 2 at least two points (factory setting, corresponds with MDx/MCx). With each additional point, the respective task obtains one more instruction/ms. Nine additional points are set using the parameters. The points are added to the standard values (1 and 2). With this setting, task 1 has highest priority, the priority of task 2 is lowered automatically.

## 4.7 Application modules

All application modules of MOVIDRIVE® A and MOVIDRIVE® compact are compatible with the B unit!

The application modules “Bus positioning”, “Expanded bus positioning” and “Table positioning” were revised and now feature improved performance. Additionally, there is the new application module “Remaining distance positioning.”

The application module “Rotary axis” and “Crane control” will not be available anymore starting from MOVITOOLS 4.0. These modules can be obtained from the A-Shell if they are still required. The new application module “Modulo positioning” is the replacement for the “Rotary axis” module.

## 4.8 Communication via SBus

Communication via SBus for MOVIDRIVE® and MOVIDRIVE® compact is set in parameters P813 to P817. With MOVIDRIVE® B, two sets are available in parameters P880 to P885. The first SBus parameter set is assigned to the basic unit. With the second parameter set, a second SBus is provided through the option card DFC.

No problems occur when an MCH in conjunction with an SBus is replaced by an MDX61B. As the clock of the MDX60B/MDX61B is 40 kHz but that of the MCH is 25 kHz, they are **not** compatible when 1 Mbaud is used. This incompatibility applies to the MCH only. All other units are compatible with each other. Compatibility can be restored by decreasing the transmission speed to 0.5 Mbaud. This restriction does not apply when all MCH are replaced by MDX61B because then all units are compatible.

## 5 Accessories

### 5.1 Plain text keypad

Six different DBG11B keypads with a total of nine languages are available for MOVIDRIVE® and MOVIDRIVE® compact. With the keypad DBG60B for MOVIDRIVE® B, all languages are stored on one unit. The languages can be selected by pressing a language key. Czech and Russian are in preparation. Both units allow for saving and copying parameter sets.



### 5.2 EMC / filters / chokes

The filters and chokes of the current MOVIDRIVE A products will not be altered and are available for MOVIDRIVE B units of sizes 0 to 6.

**Sizes 0,1,2:** These sizes come with a line filter installed as standard. The input filter ensures that class A limit is maintained on the supply side. Use a line filter as option to maintain class B limit.

**Sizes 3 to 5:** A line filter is required to maintain class A and B limits.

**Size 6:** Class A limit can be maintained by using a line filter.

### 5.3 Braking resistor

The braking resistors of the current MOVIDRIVE A products will not be altered and are available for MOVIDRIVE B units of sizes 0 to 6. For size 0, the additional braking resistor **BW090-P52B** exists, which is suited for direct mounting. The braking resistor has a continuous power of 100 W. No additional mounting material is required and, as before, the inverters can be installed without any distance between the units.

### 5.4 Serial interface

USS21A is available as interface converter RS232/RS485 for MOVIDRIVE® and MOVIDRIVE® compact. The interface converter UWS21A, as known from MOVITRAC®07, is required for MOVIDRIVE® B. In addition, an interface will be provided for converting USB/RS485. The interface inverter UWS11A for simultaneous connection of the PC to several MOVIDRIVE® units can be used like with the MOVIDRIVE® A units.



### 5.5 Line regeneration and DC link connection

The MDR60A line regenerators in 37 kW and 75 kW familiar from the MOVIDRIVE® A series have been completed with a 132 kW line regeneration. The project planning guidelines for the operation of MOVIDRIVE® units on line regenerators and the project planning guidelines for the connection of the DC links remain the same and are described in "MOVIDRIVE® drive inverters, DC link connection."

## 6 Summary

The MOVIDRIVE® B unit is highly compatible with its predecessors MOVIDRIVE® A and MOVIDRIVE® compact. When changing to MOVIDRIVE B, it is important to take into account the different dimensions and in some cases the different encoder plugs. For the latter, SEW-EURODRIVE offers adapters for fast and fault-free exchange. MOVITOOLS software version 4.0 and higher and the UWS21A interface are required for connection to the PC. In most cases, the accessories can still be used. Programming and application modules also run in the B unit.